

# AE Security Group

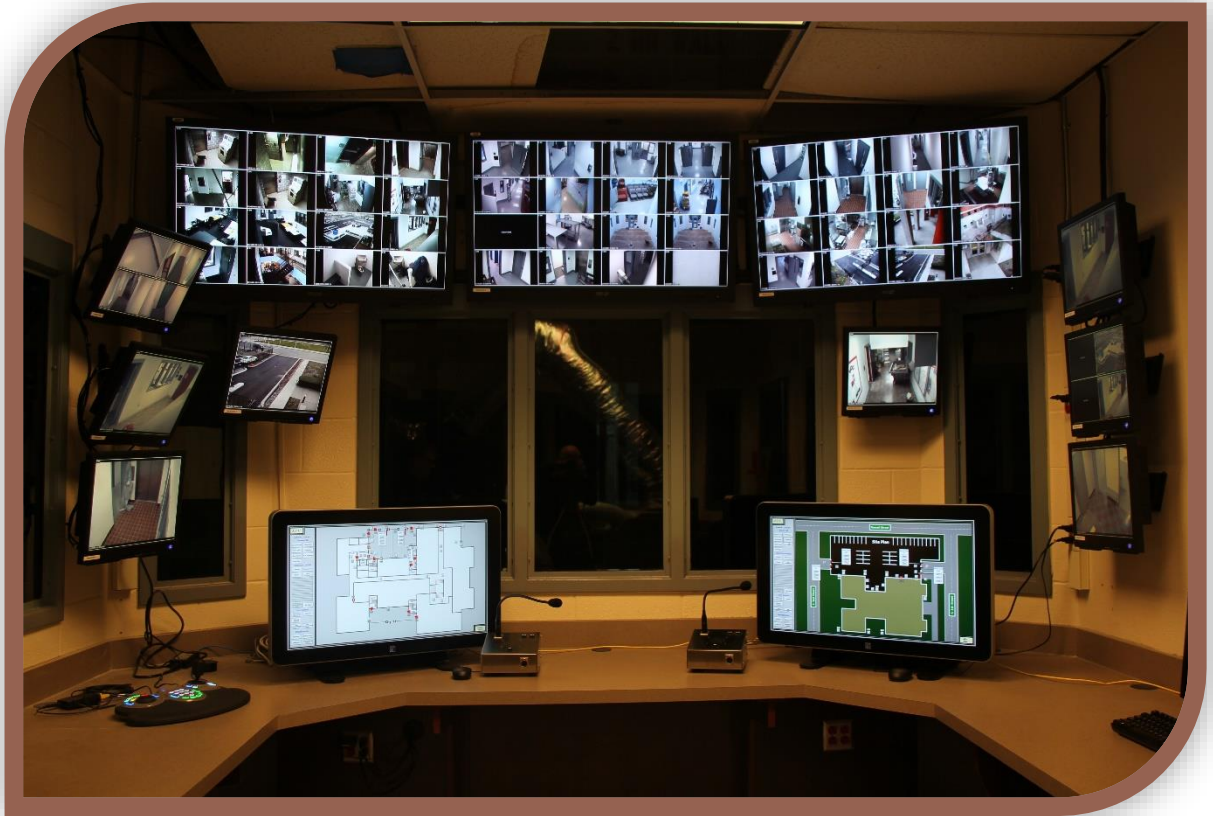

Qualification Statement



AE Security Group

### Executive Summary

AE Security Group (d/b/a of AE of Ohio, Inc.) is an experienced security system contractor for prisons and jails. We are located in Columbus Ohio with an office outside Atlanta in Morrow, Georgia.



AE is an authorized and skilled installer of the following key products:

- HMI Touch Screens
- PLC
- Intercoms and Paging
- CCTV
- Card Access

[Go To Contents](#)

Wonderware HMI Touch Screens



## Contents

Executive Summary .....	1
Contents .....	2
Company Profile .....	4
Past History.....	5
Key Technical Personnel - Software .....	6
Key Technical Personnel - Hardware .....	7
Macon State Prison .....	8
Macon State Prison – PLC Panel (1 of 12) .....	9
Macon State Prison – Central Control HMI Screen .....	10
Georgia Diagnostics and Classification Prison.....	11
Georgia Diagnostics and Classification Prison.....	12
Summit County Jail – Intercom System Retrofit.....	13
Allen County Correction .....	14
Nashville Juvenile Justice Center.....	15
Nashville Juvenile Justice Center – Central Control .....	16
Madison County Correctional Facility (#2) .....	17
Northeast Pre-Release Center (Women’s Prison).....	18
Madison County Correctional Facility (#1) .....	19
Summit County Courthouse (plus the Ohio Building) ..	20
Summit County Juvenile Court (and Jail).....	21
Older Projects – Page 1 .....	22
Older Projects – Page 2 .....	23
Older Projects – Page 3 .....	24
Older Projects – Page 4 .....	25
Older Projects – Page 5 .....	26

Letter of Recommendation #1 .....	27
Letter of Recommendation #2 .....	28
Letter of Recommendation #3 .....	29
Letter of Recommendation #4 .....	30
Product Authorization – Wonderware HMI .....	31
Product Authorization – Harding Instruments .....	32
Product Authorization – Telecor Intercom System .....	33
Product Authorization – Bosch Security System .....	34
Product Authorization – Senstar Protection Systems ..	35
PLC, Intercom, CCTV and Card Access Diagram .....	36
PLC HMI Touch Screen Diagram .....	37
PLC and Touch Screen Network .....	38

## Company Profile

AE Security Group is an experienced security systems integrator specializing in prisons and jails. Using Wonderware HMI and PLC's – AE designs, builds and integrates the electronic security system controls.

AE – with many years of experience – design, builds, installs and programs the security systems we contract for. We use no sub-contractors for any of these key elements.

AE Security Group is a d/b/a of AE of Ohio, Inc. AE was established in 2001. AE was incorporated in 2005 as a sub chapter S corporation. The president of AE is Christine Crawford and she owns 100% of the corporation's stock.

AE is an authorized integrator of Wonderware HMI, Bosch Security Systems, Harding Instruments and Telecor Intercom Systems, Allen-Bradley and GE PLC's, Senstar Perimeter systems along with other related security products. Letters of authorization are include following the projects.

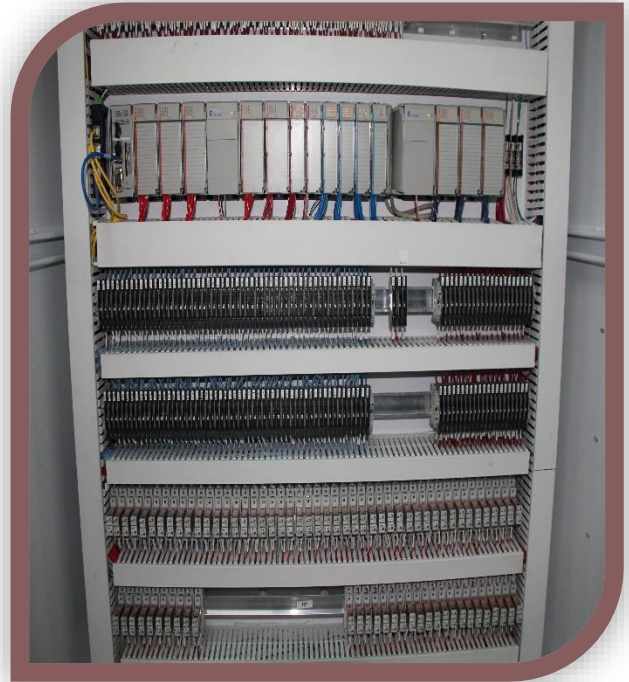

## Past History

In 2001 AE was formed to finish the security system installation at the new Ohio State Penitentiary – SuperMax prison. The security system (locking control, CCTV, intercom, duress, etc.) for this maximum security prison was being installed by an integrator who wasn't able to complete the project. The state of Ohio through Battelle Labs (a fortune 500 company located in Ohio) was tasked to find a company who could replace the current integrator and complete this complicated system (24 touch screens with 5 redundant PLC's, 200 cameras, etc.).

Through contacts with Battelle, Jim Kornman was approached to see if he might be interested in this work. Mr. Kornman at the time was working for another company installing and programming complex industrial automation equipment for various companies such as Honda, GM, US Army, Honeywell and others. With 15 years of PLC programming experience – Mr. Kornman accepted this offer and formed a company with several associates he had been working with. This was the start of AE of Ohio (d/b/a AE Security Group).

**Past Projects.** In the following pages 10 plus projects are detailed with contact information. Additionally we have provided:

- Letters of recommendation.
- Manufactures certification letters.

System design information and additional past project information can be found at our web site:

[www.aesecuritygroup.com](http://www.aesecuritygroup.com)



## Key Technical Personnel - Software

AE's primary focus is the design, build and integration of PLC based systems. The key technical employee of AE is Jim Kornman with 30 years' experience in the design, build, integration and programming of PLC based automation systems. Industrial automation system retrofits at Honda Manufacturing to the security system retrofit of 26 touch screens and PLC controls at a SuperMax penitentiary in Ohio are representative of this background.



Attached are five letters of recommendation for recent security system integration work by AE. All projects included Allen-Bradley PLC controls integrated to Wonderware touch screens. Most all of the projects had multiple housing units with remote PLC racks utilizing Ethernet protocol communicating over fiber to Master Control. The five letters are from the following organizations:

1. PB Heery Americas, Inc.
2. State of Ohio (several security systems)
3. Allen Correctional Institution (state prison)
4. Madison Correctional Institution (state prison)
5. Shremshock Architects

The second key individual is Jeff Pyles with 14 years' experience designing and integrating Wonderware projects. Jeff serves as our chief Wonderware designer along with project management duties. Many of Jeff's screen designs can be found on our web site under [Projects](#). A link to our web site is:

[www.aesecuritygroup.com](http://www.aesecuritygroup.com)

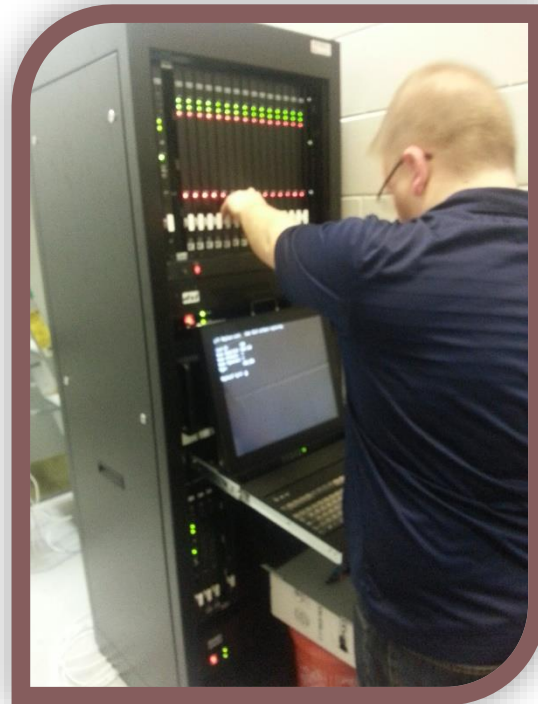

## Key Technical Personnel - Hardware

Mike Crawford is our key individual for the construction and installation of our security system enclosures. Mike has been with AE since 2001.

Greg Pyles – after returning from active duty in Iraq and Afghanistan – has been applying his many talents to our panel building duties



Harding Instruments Intercom System Panel – before and after the intercom system retrofit.

In partnership with division 16 and 26 electrical contractors - AE provides the complete physical installation of the electrical/electronic security system infrastructure such as conduit, fiber optics and cable.





## Macon State Prison



In early 2013, AE Security Group was awarded the security systems integrator contract to retrofit the entire Macon State Prison Locking Control System. All existing locking control and push button operator panels were replaced with new PLC panels and a custom Touch Screen user interface. All software and hardware meet the new standards established by The Georgia Department of Corrections in 2012.

- 12 New PLC Controls with two additional remote bases (GE)
- 12 Custom Locking Control Panels
- 28 Touch Screens (Wonderware)
- Over 900 Doors
- Tower and Gate Controls

Contract amount: \$700,000.00

Ken Stone, Georgia Department of Corrections

478.992.5298

stonek00@dcor.state.ga.us

## Macon State Prison – PLC Panel (1 of 12)

PLC Brand: GE RX3i PLC

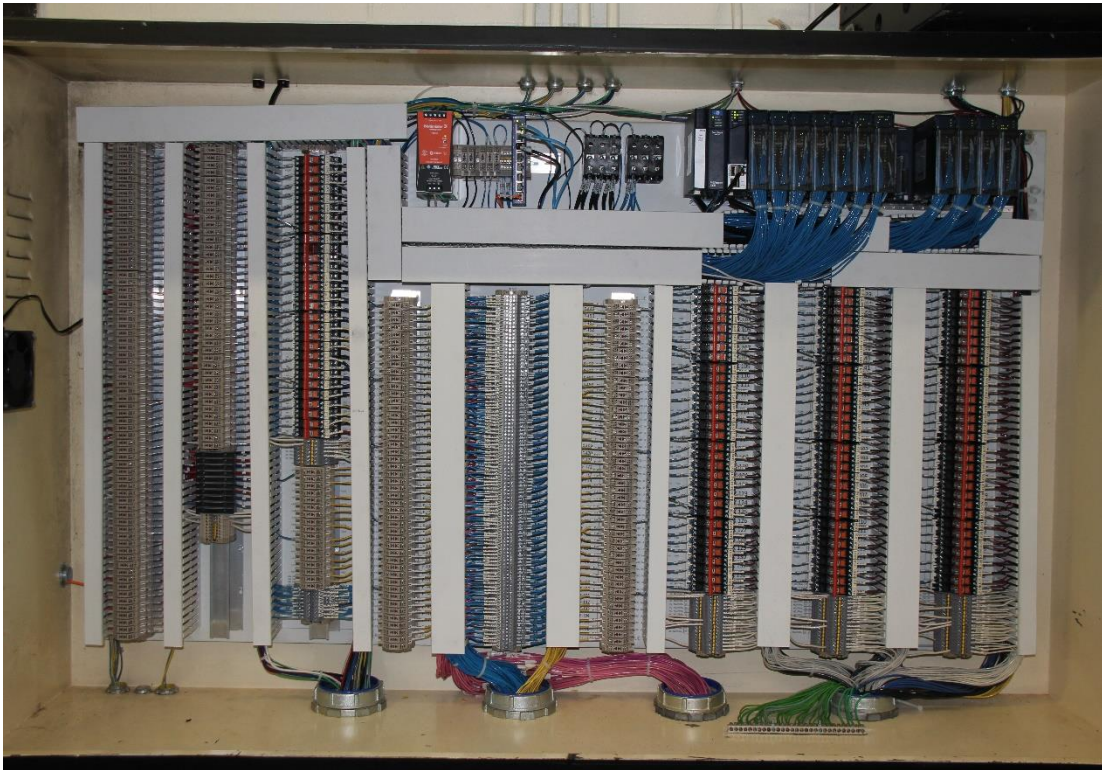

Each housing unit has 96 cells plus exit doors controlled by the PLC. Additional PLC controls for the lights and fans were also provided.

The **old locking control system (on right)** was replaced by a new GE PLC's and Wonderware Touch Screens.

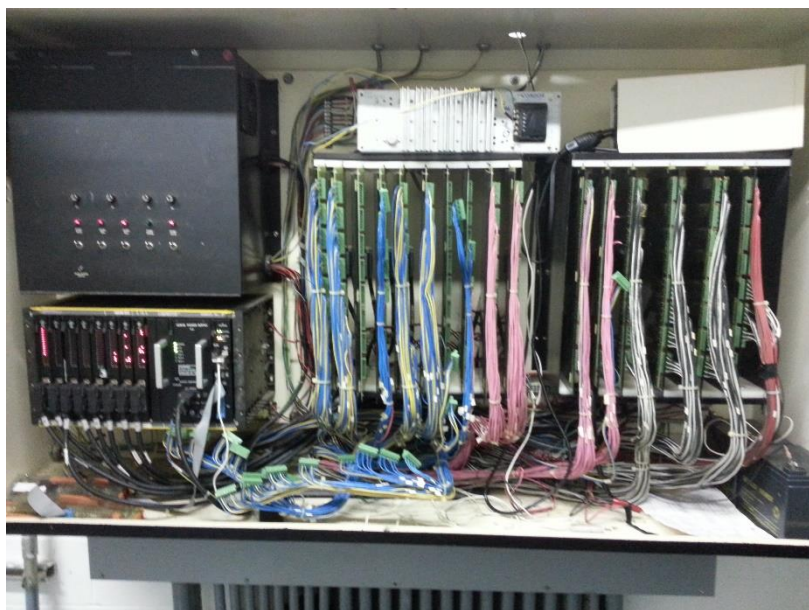

## Macon State Prison – Central Control HMI Screen

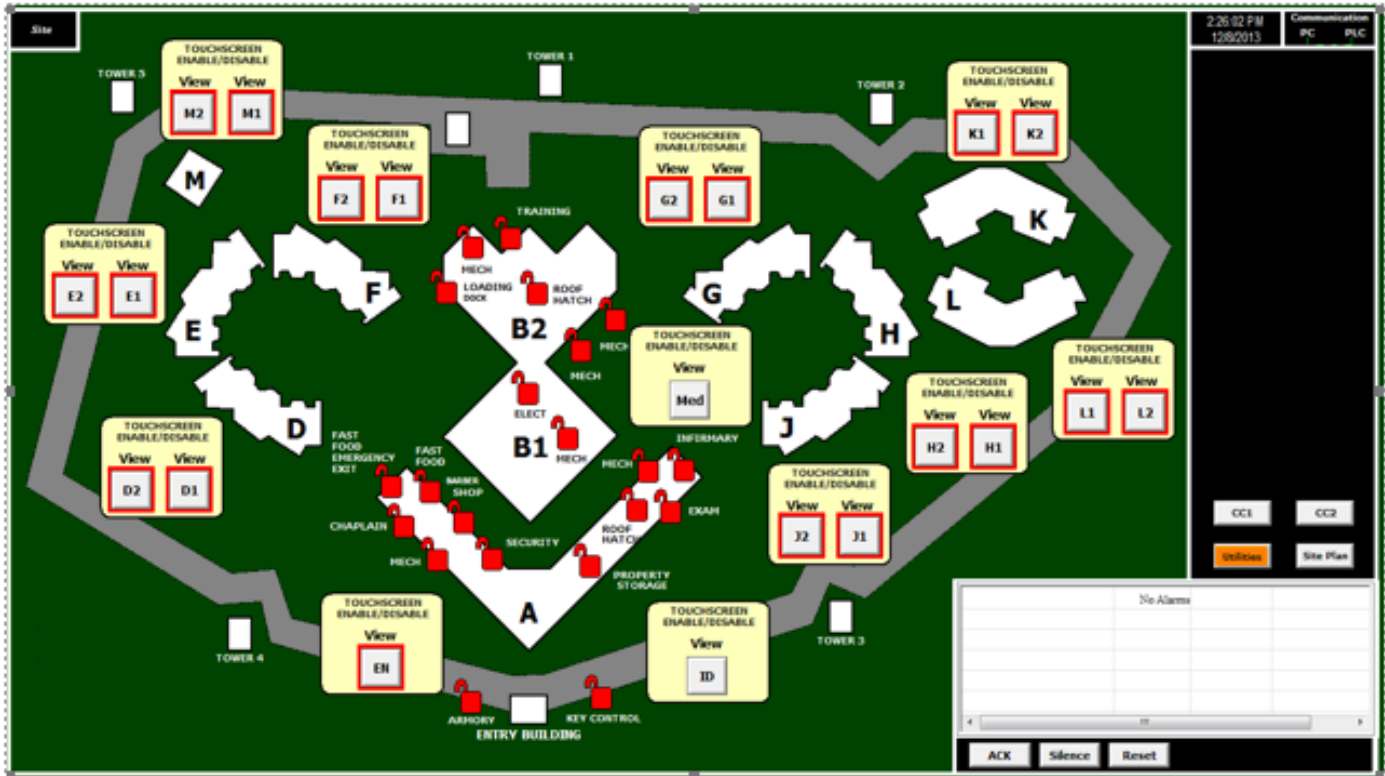

This Wonderware project allows the Central Control officer to do the following:

- Take-Over any one of the 26 touch screens in the prison housing units.
- Monitors door status on local doors.
- Receive and respond to Panic alarms that come from any one of the 26 touch screens in the housing units.
- Receive and monitor alarms

## Georgia Diagnostics and Classification Prison



In 2012, AE Security Group was awarded the security systems integrator contract to retrofit four G House control rooms at the Georgia Diagnostic and Classification Prison in Jackson, GA. All existing locking control and push button operator panels were replaced with new PLC panels and a custom 32" Touch Screens. The project was customized to meet strict Death Row protocol and included features such as: deadlock indication, duress, cell lockdown, and sticky notes. All software and hardware was purchased and designed to meet the new standards established by The Georgia Department of Corrections in 2012.

- 4 New PLC Controls (GE)
- 2 Custom Locking Control Panels
- 4 32" Touch Screens (Wonderware)
- Audible duress alarms

Contract amount: \$170,000.00

Ken Stone

Georgia Department of Corrections

478.992.5298

stonek00@dcor.state.ga.us

## Georgia Diagnostics and Classification Prison



In 2012, AE Security Group was awarded the security systems integrator contract for the design, build and installation of a perimeter roof top detection system for 'death row' at Georgia's most secure prison.

- Senstar Microwave Perimeter Detection System
- Bosch CCTV cameras and DVR (network)
- PC Control Interface

Contract amount: \$72,424.00

Ken Stone  
Georgia Department of Corrections  
478-992-5298 office  
478-992-5296 fax  
stonek00@dcor.state.ga.us

## Summit County Jail – Intercom System Retrofit



In 2011, AE Security Group was awarded the security systems integrator contract to retrofit the existing intercom system at the Summit County Jail. The entire head-end system was removed and replaced with a **Harding Instruments** Microprocessor based system that included new paging amplifiers, intercoms w/ in cell radio, house phones, pod phones, and master stations. The new system included the necessary equipment and network infrastructure to provide 100% redundancy.

- Over 400 New Cell Intercoms w/ In Cell Radio Feature (Harding Instruments)
- Over 700 Total Intercoms
- Redundant Network
- Redundant CPUs
- 10 Paging Zones
- Over 40 House Phones
- 30 Master Stations
- 16 Pod Phones

Contract amount \$510,000.00

Tom Hathaway

Summit County Jail

330.643.2171

## Allen County Correction



In 2010, AE Security Group was awarded the security systems integrator contract for a locking control retrofit at the Allen County Correctional Facility. All existing controls were removed and replaced with a modern PLC/Touch Screen system.

- PLC System with Remote I/O (Allen-Bradley)
- 6 Remote PLC's
- 12 Custom Control Touch Screens (Wonderware)
- 700 Doors
- Gate Control

Contract amount: \$292,000.00

Ray Cheney  
Allen Correctional Inst.  
419-224-8000 x 2225  
Raymond.Cheney@odrc.state.oh.us

## Nashville Juvenile Justice Center

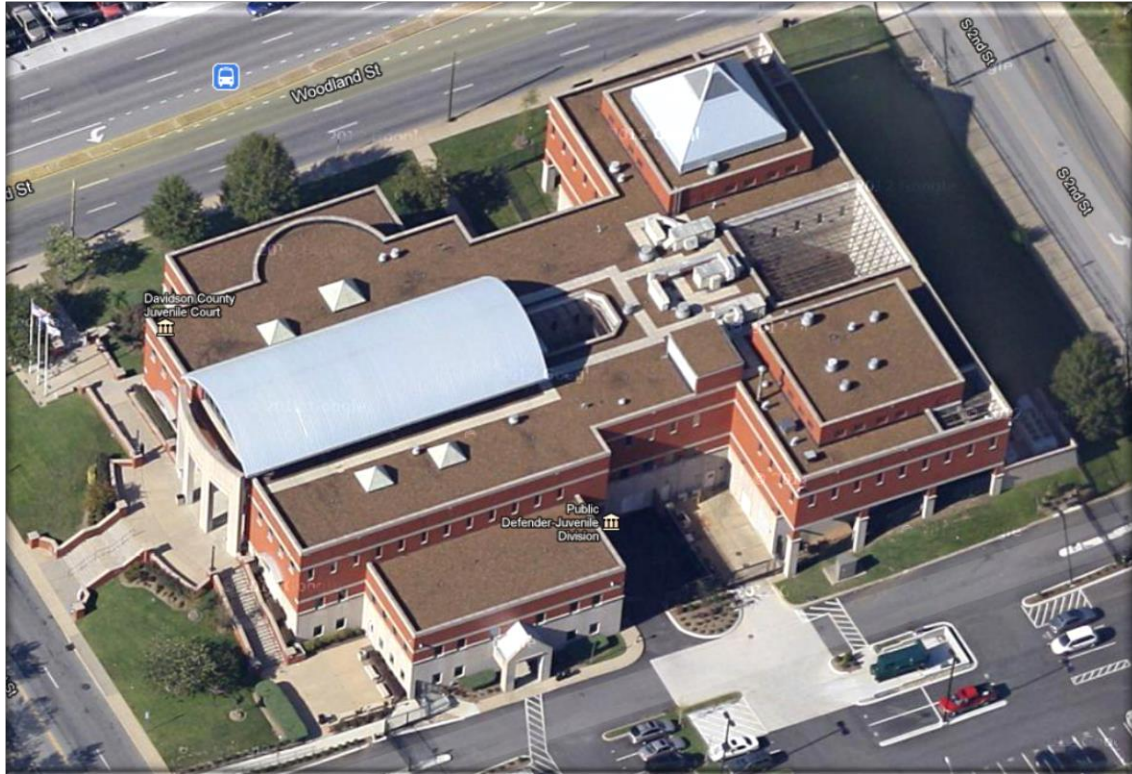

In 2010, AE Security Group was awarded the security systems integrator contract for a project for Nashville Metro and FEMA. They were contracted to replace and retrofit the existing electronic control system at the Nashville Juvenile Justice Center. This system was destroyed after massive flooding in early 2010. The new PLC/HMI system integrated with Johnson Control's card access and CCTV systems.

- Replace 3 existing Graphic Panels with one new HMI Touch Screen (Wonderware)
- Install and program new PLC's to control approximately 75 doors (Allen-Bradley)
- Integrate intercom system
- Add nine new public address paging zones
- Integrate with card access
- Control over 150 Pelco Endura IP Cameras
- Custom Digital Watch Tour
- Elevator Control

Contract amount: \$224,000.00

Glen Cook  
G4S Youth Services, LLC (Nashville)  
Assistant Superintendent  
615-394-2419  
GlennCook@jjs.nashville.org



## Nashville Juvenile Justice Center – Central Control



*Nashville Central Control Room*

*Before and after the security system retrofit by AE Security Group*



[Go To Contents](#)

## Madison County Correctional Facility (#2)



In 2009, AE Security Group was awarded the security systems integrator contract for a facility wide control system upgrade at the Madison County Correctional Facility.

- 10 PLC System CPU's with Remote I/O (Allen-Bradley)
- Upgraded Existing Man Down System
- 12 Custom Control Touch Screen (Wonderware)
- 600 Doors
- 12 Fiber Optic Cameras
- Custom Control Center Console Installation
- Gate Control

Contract amount: \$475,077.00

Brian Dille  
Madison Correctional Institution  
Head of Maintenance  
740-852-9777  
Brian.Dille@odrc.state.oh.us

## Northeast Pre-Release Center (Women's Prison)



In the spring of 2009, AE Security Group was awarded the security systems integrator contract to upgrade the existing locking control panels at the Northeast Pre-Release Center.

- PLC System with Remote I/O (Allen-Bradley and Wonderware)
- Fiber Optic Communication Between Housing Units
- 8 Housing Units
- 82 Doors
- Gate Control
- Loop Detector

Contract amount: \$224,000.00

Jim Monyak

Northeast Pre-Release Center

(216) 771-6460

Jim.Monyak@odrc.state.oh.us

## Madison County Correctional Facility (#1)



In 2008, AE Security Group was awarded the security systems integrator contract for the retrofit of the security touch screen controls for 8 housing units at the Madison County Correctional Facility.

(This project was phase 1 of the total Madison County Correctional Facility)

- 10 PLC System CPU's with Remote I/O (Allen-Bradley)
- 12 Custom Control Touch Screen (Wonderware)
- 600 Doors

Contract amount: \$459,000.00

Brian Dille  
Madison Correctional Institution  
Head of Maintenance  
740-852-9777  
Brian.Dille@odrc.state.oh.us

## Summit County Courthouse (plus the Ohio Building)

### Summit County Courthouse



In the Fall of 2004, AE was awarded a contract to perform the installation and programming of the entire technology/security portion of the new 70,000 sq. ft. Domestic Relation Courthouse in Akron, OH. In addition, AE provided security upgrades and networking functions to two adjacent government buildings in order to create a fully integrated system.

#### Project Included:

- 62 Cameras
- 4 Networked Digital Video Recorders
- Remote Viewing Stations
- Campus Wide Access System
- Graphical User Interface to Operate Integrated Systems
- Over 400 Tele/Data Drops
- Over 100 Fiber Optic Terminations
- Wireless Duress System

In 2012 - AE retrofitted the Ohio Building connected to the Summit County Courthouse with card access (Bosch), CCTV (Bosch) and locking control. Same contacts for both projects.

Contract Amount for Courthouse and Ohio Building: \$450,000.00

Jon Holland  
Summit County  
jholland@summitoh.net  
(330) 926-2492

## Summit County Juvenile Court (and Jail)

### Summit County Juvenile Court



In 2002, AE provided and installed all new security components and devices for the over 100,000 square foot addition/renovation of the Summit County Juvenile Detention Facility and Courthouse.

#### Project Included:

- **128 Cameras**
- 8 Remote Viewing Stations
- **Locking Control Panel** - manufactured a Programmable Logic Controller (PLC) door locking/unlocking system.
- **Intercoms/Paging** - installed over 200 sub-station intercoms with zone paging and listening capabilities - microprocessor based.
- **Access** - Installed a proximity type door access system with over 200 readers and a badging workstation.
- **Administrative Telephone** - 16 station capability for control room and classroom communications.
- **Touch screen / HMI / PLC** - Installed a networked computer system using floor plan graphics of the areas being monitored. Icons were used to switch cameras, enable intercoms and open/close the doors at 8 remote touch screen locations.
- **Digital CCTV Recorders** - Installed digital video recorders to record all 128 cameras with 128 channels of audio.
- **CCTV Monitors** - Installed a network of CCTV monitors to display the selected cameras.
- **Fire** - Designed and installed complete fire alarm system.
- **Court Room Sound** - Designed and installed complete sound reinforcement system for the courtrooms.
- **X-Ray and Metal Detectors** - Installed an X-Ray and metal detector in the courthouse lobby.

Contract Amount: \$650,000.00

Jon Holland

Summit County

[jholland@summitoh.net](mailto:jholland@summitoh.net)

(330) 926-2492

## Older Projects – Page 1

### Swain County Law Enforcement Center



In the Spring of 2007, AE was awarded a contract to install an AE Detention Control System for a new law enforcement building in Bryson City, NC. The new facility houses 109 inmates and the county 911 dispatch center.

- New AE Detention Control System
- 2 Custom Touch Screens
- 110 Intercom Sub-stations
- 70 Cameras
- 110 Doors
- Card Access System

### MonDay Correctional Facility



In early 2007, AE retrofitted the existing touch screen/PLC system at the MonDay Correctional Facility in Dayton, Ohio. AE replaced the existing touch screens and integrated new CCTV cameras into the AE Detention Control System.

- Upgrade to AE Detention Control System
- New Custom Touch Screens
- 16 Additional Cameras

## Older Projects – Page 2

### US Department of Agriculture Athens, GA



In the Fall of 2006, AE was contracted by the US Department of Agriculture to upgrade their facility to Homeland Security standards.

- Card Access Control System
- Video Intercom System
- Facility Gate Control

### White County Courthouse



In the Summer of 2006, AE was contracted by White County, GA to perform security upgrades and additions to their existing facility. The AE Detention Control System included locking control, card access, CCTV, intercoms and a duress system.

- New AE Detention Control System
- Campus Wide Card Access System
- Graphical user Interface to Operate Integrated Systems
- 20 Cameras
- 2 Networked Digital Video Recorders
- Remote Digital Video Recorder Access
- Video Intercom System



## Older Projects – Page 3

### West Central Community Correctional Facility



In 2006, AE was again contracted by the ODRC. AE upgraded the West Central Community Correctional Facility's existing Montgomery Technology locking control panel to a new AE Detention Control System. In addition to the upgrade, AE provided the technology and security portion of the entire 20,000 sq. ft. women's addition.

- New AE Detention Control System
- Replaced Existing Graphic Control Panel with Custom PC Based Touch Screen
- 50 Intercom Sub-Stations
- 25 Cameras
- 4 Networked Digital Video Recorders

### Lorain/Medina Community Correctional Facility



In late 2005, AE was awarded a contract by the ODRC to upgrade the Lorain/ Medina Community Correctional Facility. AE replaced the existing SimplexGrinnell locking control system with an AE Detention Control System.

- New AE Detention Control System
- Replaced Existing Graphic Control Panel with Custom PC Based Touch Screen
- 50 Intercom Sub-Stations
- 40 Doors

## Older Projects – Page 4

### Hamilton County Juvenile Court - Hillcrest Training School



In early 2011 AE upgraded the existing analog camera system at the Hillcrest Training School.

- Campus-wide IP Camera System
- 48 New Cameras
- New Cisco PoE Network
- 3 Digital RAID 5 NVR's
- New Network Video Viewing Station

(Hamilton County sold the facility to a private company in 2012)

### Federal Reserve Bank of Cleveland Pittsburgh Branch



In 2004 AE provided a complete locking control system at the Federal Reserve in Pittsburgh, PA. In partnership with SimplexGrinnell, AE developed the touch screen displays, installed the PLC system and wrote the ladder logic. This system operates and monitors critical doors throughout the Federal Reserve.

AE was contracted again by the Federal Reserve/SimplexGrinnell in 2007. AE expanded the system to provide additional door control of the loading docks which allowed secure movement of money to and from the facility.

Project Included:

- New AE Detention Control System
- 2 Custom Touch Screen Projects
- 30 Doors
- Custom Panel

## Older Projects – Page 5

### Ohio State Penitentiary Touch Screen Upgrade & Exterior Recreation Expansion



AE was contracted by Battelle Labs in the Summer of 2001 to retrofit the existing security system at the Ohio State Penitentiary in Youngstown, Ohio. This facility is one of 5 SuperMax security prisons in the United States. AE personnel retrofitted the 26 touch screen controls and re-worked the PLC door control logic. In addition, AE added new custom features to the touch screens that provided color coded tracking of inmate movements (i.e. in shower, medical, etc.)

In 2003, AE designed and installed a new touch screen/PLC system to control eight new recreational sections added to the facility. This contract consisted of an AE Detention Control System which added control and monitoring for eight automated elevators, new electric doors, intercoms and CCTV. In addition, all 26 of the existing touch screens/PLC controls were edited to include the new graphics for the eight new areas of the facility.

#### Project Included:

- 5 Redundant PLC's
- 24 Touch Screen Projects
- 800 Doors
- 80 Intercom Sub-Stations
- 68 Cameras
- 15 Remote Monitoring Locations

## Letter of Recommendation #1



To whom it may concern:

In the September of 2010 until June of 2011 – AE of Ohio was one of the sub-contractors working for Johnson Controls Inc. on Juvenile Justice Center flood recovery project in Nashville, Tennessee. Jim Kornman was the project management and personally supervised all of the work supplied by the security integration team from AE of Ohio, Inc. as part of their assignment for recovery/repair of existing security components along with design/installation of a new security system for the above noted Juvenile Justice Center facility in Nashville, Tennessee.

Mr. Kornman provided the security integration project management, system integration design/review and programming on this project.

Mr. Kornman and the AE of Ohio, Inc. project staff satisfactorily completed this project according to the specifications provided by the City of Nashville and Johnson Controls. We are very pleased with the professionalism, attention to detail, quality and the adherence to the project's accelerated schedule that the AE of Ohio staff brought to the project team.

I plan to make every effort to see that AE of Ohio is listed as approved security system integration contractors for any future security projects that I might have and I would highly recommend them to others for any similar security project assignments.

Sincerely,

A handwritten signature in blue ink that reads 'Kenneth Crews'.

Kenneth Crews  
Sr. Project Manager  
PB/Heery  
Nashville Metro Flood Recovery Team  
(586) 634-8364

## Letter of Recommendation #2



Architects & Engineers  
6130 S. Sunbury Rd.  
Westerville, OH 43081

t 614 545 4550  
888 373 4130  
f 614 545 4555

[www.shremshock.com](http://www.shremshock.com)

July 18, 2011

To whom it may concern:

Between the years of 2009 and 2011, Mr. Jim Kornman and AE of Ohio, Inc. performed work as a sub-contractor to the General Contractors on projects at three existing institutions for the Ohio Department of Rehabilitation and Corrections and the Ohio Department of Youth Services.

Mr. Kornman's responsibilities on two of the above mentioned projects included the system design and programming for a new door control system and its integration with the other existing security systems. In addition to the door control system, the third project also included new cameras and fiber optic backbone. Mr. Kornman and AE of Ohio, Inc. were valuable members of the team and completed all work satisfactorily in accordance with the project drawings and specifications provided by Shremshock Architects, Inc. and its consultants.

Shremshock would not hesitate to recommend Mr. Kornman for any work he felt he was capable of performing.

Sincerely,

Timothy Princehorn  
Shremshock Architects, Inc.

## Letter of Recommendation #3



### Ohio Department of Rehabilitation and Correction

Allen Correctional Institution  
2338 North West Street  
P.O. Box 4501  
Lima, OH 45802

John R. Kasich, Governor

[www.drc.ohio.gov](http://www.drc.ohio.gov)

Gary C. Mohr, Director

#### To Whom It May Concern:

In 2010 AE of Ohio was the firm contracted for the engineering and installation of the A.C.I. institutional locking system retrofit. During a period of about nine months I had a great deal of contact with Jim Korman as project manager, programmer, and installer. I was impressed with Jim's knowledge and engineering background, along with his common sense approach to any problems or issues that occurred. From the beginning of the project Jim always took the time to explain any changes or issues that occurred. I was impressed with the quality of his work and his attention to detail. In the end I was handed a locking system that was reliable, state of the art, and easy to troubleshoot. Once the project was completed Jim made sure we had all the spare parts necessary to maintain the system, although repairs have been at a minimum. In closing, my experience working with Jim Korman on this project was great and I would be happy to work with him in any capacity in the future.

Sincerely,  
Ray Cheney  
Telecom Tech 2  
Allen Correctional Inst.

[Go To Contents](#)

## Letter of Recommendation #4



### Ohio Department of Rehabilitation and Correction

MADISON CORRECTIONAL INSTITUTION

P.O. BOX 740

London, Ohio 43140-0740

Date: July 21, 2011

As the Building Maintenance Superintendent II at Madison Correctional Institution I have had the opportunity to work with Jim Komman on two separate occasions.

The first project was a Locking Retrofit. The project began in August 2008 and was completed in March 2009. During this project Jim was the project manager for A.E. of Ohio and also played a huge role in the installation and programming. The second project was a Control Center Renovation. This project took place in July 2009 through August 2010. During this project A.E. of Ohio was a sub-contractor and Jim's role was programming and installation.

On both occasions it was a privilege to work with Jim. He always displayed a high level of professionalism and knowledge in his trade pertaining to installation and programming.

Brian Dille, BMS II

## Product Authorization – Wonderware HMI

This is to Certify that

**AE of Ohio, Inc.**

is an

**Invensys Wonderware**

**Registered**

**System Integrator**

Effective as of:  
May 4, 2011

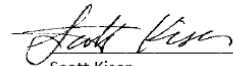

Scott Kiser  
Director, System Integrator Programs  
Wonderware





**Product Authorization – Harding Instruments**

# Certificate of Achievement



## Jim Korрман

*Has completed the MicroComm DXI/DXL Application Specialist Training Program and exhibited a thorough understanding of the principles, features, and benefits of the MicroComm DXI and DXL Intercom Systems. The trainee is qualified to provide design, configuration, installation, commissioning, and maintenance services for the MicroComm DXI and DXL product families.*

*Through these accomplishments, Harding Instrument Co. Ltd. certifies the above named person as a MicroComm DXI/DXL Technical Specialist.*



  
\_\_\_\_\_  
President

  
\_\_\_\_\_  
Instructor

May 15-17, 2012  
\_\_\_\_\_  
Date

## Product Authorization – Telecor Intercom System



[Go To Contents](#)

## Product Authorization – Bosch Security System



# BOSCH

Bosch Security Systems  
850 Greenfield Road  
Lancaster, PA 17601  
[www.boschsecurity.us](http://www.boschsecurity.us)

March 20, 2012

### Authorized Dealer Letter

To Whom It May Concern:  
By copy of this letter please be advised

**AE Security Group**  
Attn: Jeff Pyles  
1919 NORTH CR 605  
Sunbury, Ohio 43074

is authorized to sell and install the Bosch Security Equipment product line.

- Intrusion Systems
- Access Controls
- Fire Systems
- CCTV Systems

AE Security Group has access to the Bosch product portfolio and our technical support staff. Bosch Security provides product protection with a 3 year warranty on most products.

Please contact the undersigned should you require additional information.

Sincerely,

A handwritten signature in black ink, appearing to read "Robert D. Drob".

Bosch Security  
Robert D. Drob  
Telephone (717) 735-6381, Facsimile (717) 735- 6560

## Product Authorization – Senstar Protection Systems



Senstar Inc.  
13800 Coppermine Road  
Herndon, VA 20171 USA  
[www.senstar.com](http://www.senstar.com)

March 20, 2012

Mr. Jeff Pyles  
AE Security  
1919 North County Road 605  
Sunbury, Ohio 43074

Re: Authorized reseller of Senstar Products

Dear Jeff,

This letter serves as confirmation that the AE Security Group is an authorized reseller of Senstar products and is factory certified for installation and maintenance.

Sincerely,

A handwritten signature in black ink that reads "Kevin F. Brooks". The signature is fluid and cursive.

Kevin F. Brooks  
Regional Manager  
Senstar, Inc.

[Go To Contents](#)

## PLC, Intercom, CCTV and Card Access Diagram

### Nashville Juvenile Justice Center - TN

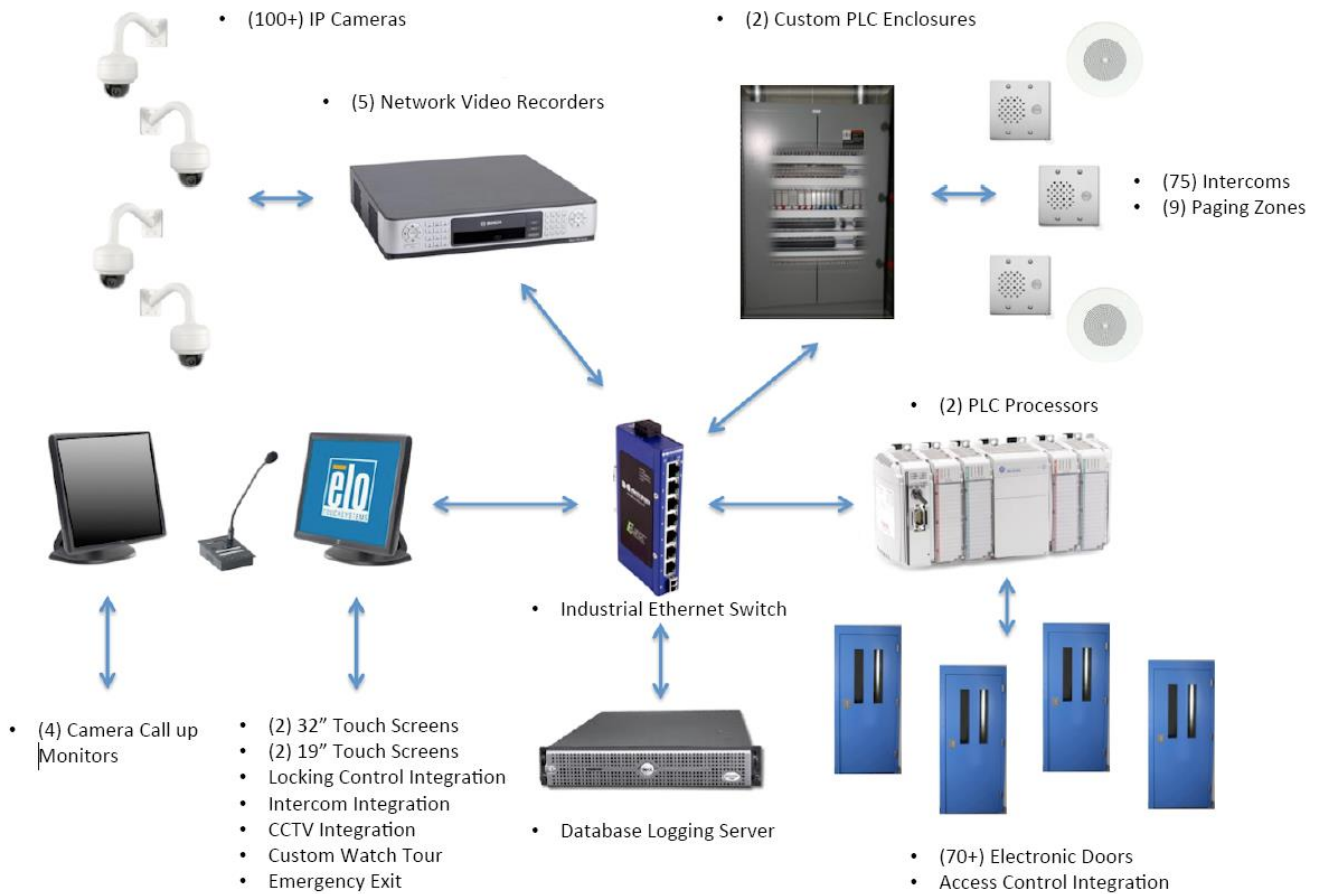

Go To Contents

## PLC HMI Touch Screen Diagram

### Macon State Prison - GA

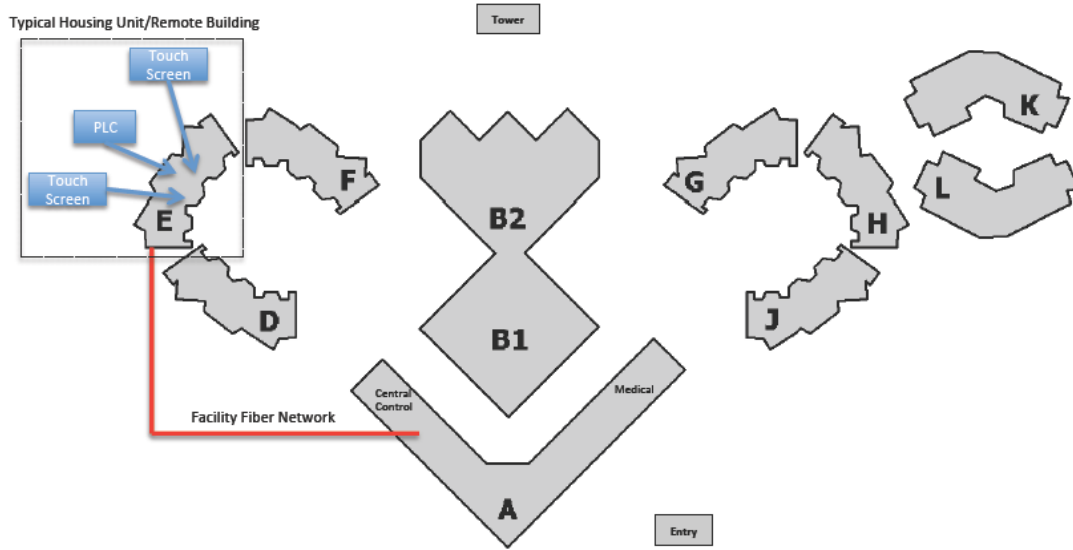

- D Building**
- (2) 32" Touch Screen Controls
  - (1) PLC Processor
  - Over (100) Electronic Doors
  - Over (100) Call-In Buttons
  - Takeover Capability

- F Building**
- (2) 32" Touch Screen Controls
  - (1) PLC Processor
  - Over (100) Electronic Doors
  - Over (100) Call-In Buttons
  - Takeover Capability

- H Building**
- (2) 32" Touch Screen Controls
  - (1) PLC Processor
  - Over (100) Electronic Doors
  - Over (100) Call-In Buttons
  - Takeover Capability

- K Building**
- (2) 32" Touch Screen Controls
  - (1) PLC Processor
  - Over (100) Electronic Doors
  - Over (100) Call-In Buttons
  - Takeover Capability

- Central Control**
- (2) 32" Touch Screen Controls
  - (2) 19" Touch Screen Controls
  - (1) PLC Processor
  - (1) Remote I/O
  - Over (30) Local Electronic Doors
  - Facility wide Database Logging
  - Complete Facility Takeover Capability

- E Building**
- (2) 32" Touch Screen Controls
  - (1) PLC Processor
  - Over (100) Electronic Doors
  - Over (100) Call-In Buttons
  - Takeover Capability

- G Building**
- (2) 32" Touch Screen Controls
  - (1) PLC Processor
  - Over (100) Electronic Doors
  - Over (100) Call-In Buttons
  - Takeover Capability

- J Building**
- (2) 32" Touch Screen Controls
  - (1) PLC Processor
  - Over (100) Electronic Doors
  - Over (100) Call-In Buttons
  - Takeover Capability

- I Building**
- (2) 32" Touch Screen Controls
  - (1) PLC Processor
  - Over (100) Electronic Doors
  - Over (100) Call-In Buttons
  - Takeover Capability

- Medical**
- (1) 19" Touch Screen Controls
  - (1) PLC Processor
  - Over (100) Electronic Doors
  - Takeover Capability

- Entry**
- (1) 19 Touch Screen Control
  - (1) PLC Processor
  - Gate Control

- Tower**
- (1) 19 Touch Screen Control
  - (1) PLC Processor
  - Gate Control

- ID**
- (1) 19 Touch Screen Control
  - (1) PLC Processor
  - (4) Local Doors
  - (2) Call-In Buttons

[Go To Contents](#)

## PLC and Touch Screen Network

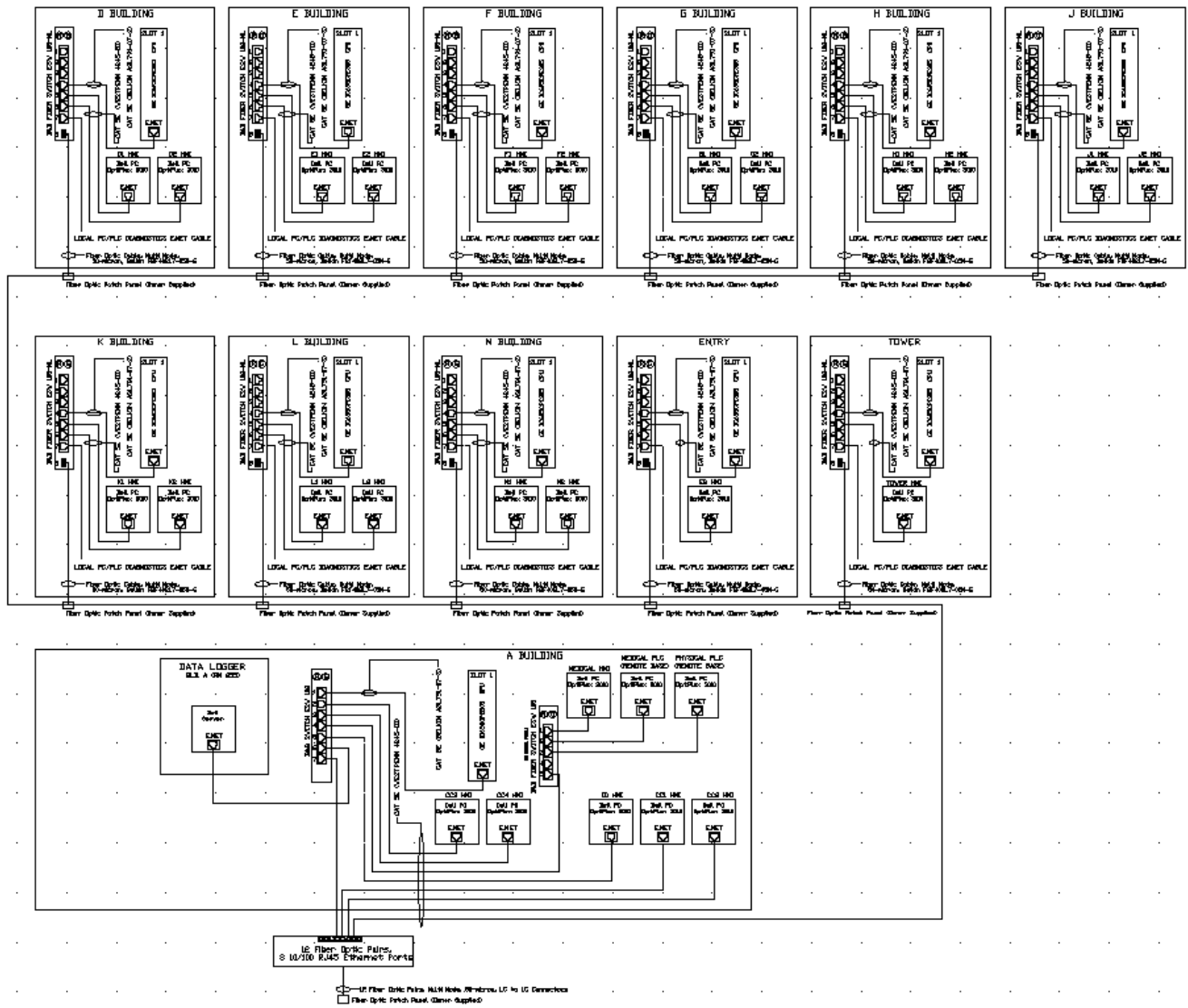

Go To Contents